



NEW ROCKET7
Hammer drill bit

SPRING / SUMMER
2024





PROJAHN

WERKZEUGE WIE DU

CREATED FOR QUALITY AND SAFETY IN EVERYDAY USE.

Your quality demands are our demands:

We manufacture tools for you that impress in terms of function, price and performance. Precise, durable and safe - tools made for everyday use. Because we know: Good work can only be done with good tools.

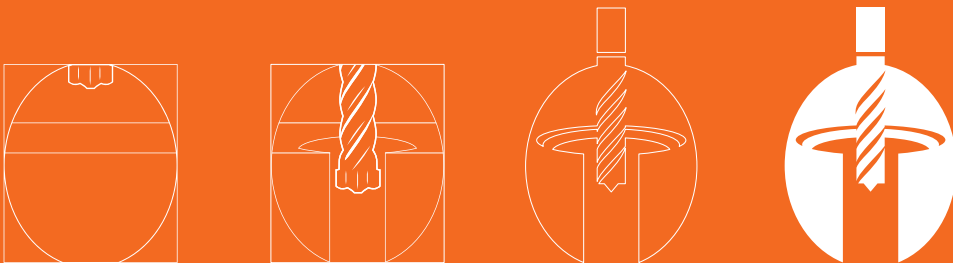

STRONG

LIKE YOU.

Discover the new ROCKET 7:

Strong, persistent, reliable. Drill in reinforced concrete and highly abrasive materials such as natural stone with the ROCKET 7. Fast and with maximum lifetime.

ROCKET 
HAMMER DRILL BIT





ROCKET7

The SPECIALIST for reinforced concrete 

ROTARY HAMMER DRILL BITS WITH 4 CUTTING EDGES SDS-PLUS

Maximum lifetime

- Solid carbide head for optimal resistance at very high temperatures - therefore perfectly suited for frequent drilling in reinforcement
- Extremely strong head connection due to an innovative diffusion welding process - therefore maximum safety against head breakages

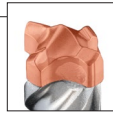

Maximum security

- Wear marks for identifying the wear limit in accordance with the PGM
- Reinforcement chamfers prevent jamming in case of reinforcement hits
- 4-spiral helix geometry for lower vibrations to protect people and machine







Extremely durable





- 4-spiral helix geometry for an evenly spread wear
- Drill bit body made of high-quality tempered steel [34CrNiMo6]



Range of application

-  - Reinforced concrete
-  - Concrete
-  - Natural stone
-  - Masonry

Characteristics

-  - Durable
-  - Powerful
-  - Precise
-  - Low vibration

Rotary hammer drill bits SDS-plus

NEW

#001				PROFESSIONAL
SDS-plus				1 piece
Ø mm	L1 mm	L2 mm	€/Pc.	Item no.
5.0	165	100	6.50	83 05 165 8
6.0	115	50	6.10	83 06 115 8
6.0	165	100	6.60	83 06 165 8
6.0	215	150	9.00	83 06 215 8
8.0	115	50	7.65	83 08 115 8
8.0	165	100	8.00	83 08 165 8
8.0	215	150	9.20	83 08 215 8
8.0	265	200	11.75	83 08 265 8

#001				PROFESSIONAL
SDS-plus				1 piece
Ø mm	L1 mm	L2 mm	€/Pc.	Item no.
10.0	165	100	8.80	83 10 165 8
10.0	215	150	10.15	83 10 215 8
10.0	265	200	12.45	83 10 265 8
12.0	165	110	10.25	83 12 165 8
12.0	215	160	12.25	83 12 215 8
12.0	265	210	14.75	83 12 265 8
14.0	215	160	19.10	83 14 215 8
16.0	215	160	25.50	83 16 215 8



TOOLS LIKE YOU:

**STRONG
PERSISTENT
RELIABLE**



ROCKET7

The SPECIALIST for reinforced concrete 

ROTARY HAMMER DRILL BITS WITH 4 CUTTING EDGES SDS-PLUS

Rotary hammer drill bit set

NEW

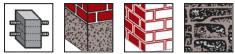

- Ø 6 x 115/50 mm
- Ø 6 - 8 - 10 x 165/100 mm
- Ø 12 x 165/110 mm



#002 PROFESSIONAL
83801 5 pieces
€ 36.⁹⁰

Rotary hammer drill bit set

NEW

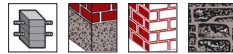

- Ø 5 - 6 - 8 x 115/50 mm
- Ø 6 - 8 - 10 x 165/100 mm
- Ø 12 x 165/110 mm



#003 PROFESSIONAL
83804 7 pieces
€ 52.⁹⁰





STONE

ROCKET5

The ALLROUNDER



HAMMER DRILL BITS WITH 4 CUTTING EDGES SDS-PLUS AND SDS-MAX

Maximum precision

- 5 Crushers use impact and torsion to create precise drill holes in reinforced concrete
- Inserted carbide cross plate for an exact centering on the drill bit body
- 4-spiral helix geometry for a high running stability and optimal guidance in the drill hole
- Pilot centering tip for precise spot-drilling without slipping off



Maximum security

- Wear marks for identifying the wear limit in accordance with the PGM
- Reinforcement chamfers prevent jamming in case of reinforcement hits
- 4-spiral helix geometry for lower vibrations to protect people and machine

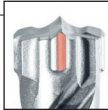

Extremely durable

- 4-spiral helix geometry for an evenly spread wear
- Drill bit body made of high-quality tempered steel [34CrNiMo6]

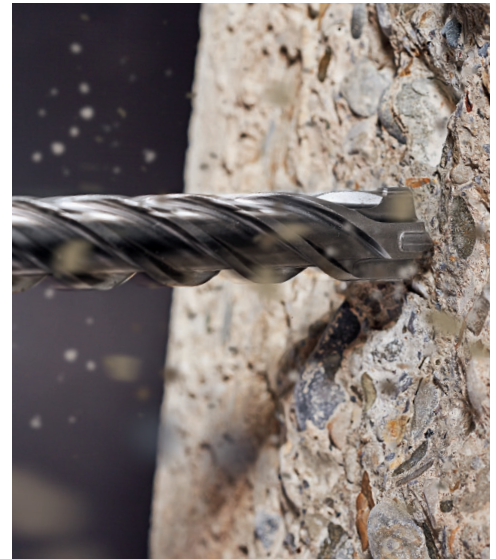

Range of application

- Reinforced concrete
- Concrete
- Masonry
- Natural stone

Characteristics

- Precise
- Powerful
- Durable
- Low vibration

Rotary hammer drill bits SDS-max

#004				PROFESSIONAL
SDS-max				1 piece
Ø mm	L1 mm	L2 mm	€ / Pc.	Item no.
14.0	540	400	63.30	814 540
16.0	340	200	53.90	816 340
16.0	540	400	64.80	816 540
18.0	340	200	54.60	818 340
18.0	540	400	67.40	818 540

#004				PROFESSIONAL
SDS-max				1 piece
Ø mm	L1 mm	L2 mm	€ / Pc.	Item no.
20.0	520	400	69.60	820 520
22.0	520	400	71.50	822 520
24.0	520	400	73.90	824 520
25.0	520	400	74.60	825 520
28.0	570	450	83.80	828 570



ROCKET5

The ALLROUNDER



Rotary hammer drill bit set

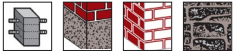

Ø 6 x 110/50 mm
Ø 6 - 8 - 10 x 160/100 mm
Ø 12 x 160/110 mm



SDS-plus

#005	PROFESSIONAL
83046	5 pieces
€	34. ⁹⁰

Rotary hammer drill bit set

NEW

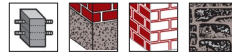

Ø 5 - 6 - 8 x 110/50 mm
Ø 6 - 8 - 10 x 160/100 mm
Ø 12 x 160/110 mm



SDS-plus

#006	PROFESSIONAL
83043	7 pieces
€	44. ⁹⁰

Rotary hammer drill bit set

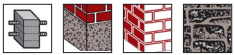

Ø 5 - 6 - 8 x 110/50 mm
Ø 6 - 8 - 10 x 160/100 mm
Ø 12 x 160/110 mm



SDS-plus

#007	PROFESSIONAL
83744	7 pieces
€	49. ⁹⁰

Hammer drill bit big packs SDS-plus **NEW**

#008		PROFESSIONAL			5 pieces
Ø mm	L1 mm	L2 mm	€ / PU	Item no.	
6.0	110	50	27.00	83 06 110 45	
8.0	210	150	37.70	83 08 210 45	
10.0	210	150	44.00	83 10 210 45	
12.0	210	160	49.40	83 12 210 45	
14.0	210	160	79.70	83 14 210 45	
16.0	210	160	104.20	83 16 210 45	

#009		PROFESSIONAL			10 pieces
Ø mm	L1 mm	L2 mm	€ / PU	Item no.	
5.0	160	100	59.90	83 05 160 410	
6.0	160	100	60.50	83 06 160 410	
8.0	160	100	66.90	83 08 160 410	
10.0	160	100	69.60	83 10 160 410	
12.0	160	110	80.50	83 12 160 410	
14.0	160	110	99.50	83 14 160 410	

#010		PROFESSIONAL			30 pieces
Ø mm	L1 mm	L2 mm	€ / PU	Item no.	
6.0	160	100	163.40	83 06 160 430	
8.0	160	100	180.60	83 08 160 430	
10.0	210	150	237.60	83 10 210 430	
12.0	210	160	266.80	83 12 210 430	





ROCKET3

The SPRINTER



ROTARY HAMMER DRILL BITS WITH 2 CUTTING EDGES SDS-PLUS

Maximum speed

- 3 crushers for extremely fast material destruction
- 2-spiral helix geometry for a rapid removal of the drilling dust

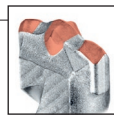

Maximum security

- Wear marks for identifying the wear limit in accordance with the PGM
- Innovative geometry of the carbide plate for an exact fit on the drill bit body
- Protruding centering tip for precise spot-drilling without slipping off

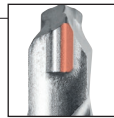

Extremely durable

- Wide spiral backs and core-reinforced helix for an even wear and high breaking stability
- Drill bit body made of high-quality tempered steel [34CrNiMo6]



Range of application



- Concrete



- Masonry



- Natural stone



- Sand-lime brick

Characteristics



- Fast



- Powerful



- Precise



- Low vibration



Rotary hammer drill bit set

- Ø 6 x 110/50 mm
- Ø 6 - 8 - 10 x 160/100 mm
- Ø 12 x 160/110 mm

#011 PROFESSIONAL
83045 5 pieces
€ 16.⁸⁰



Rotary hammer drill bit set

NEW

- Ø 5 - 6 - 8 x 110/50 mm
- Ø 6 - 8 - 10 x 160/100 mm
- Ø 12 x 160/110 mm

#012 PROFESSIONAL
83049 7 pieces
€ 25.⁵⁰



Rotary hammer drill bit set

- Ø 5 - 6 - 8 x 110/50 mm
- Ø 6 - 8 - 10 x 160/100 mm
- Ø 12 x 160/110 mm

#013 PROFESSIONAL
83730 7 pieces
€ 30.⁵⁰



#014				PROFESSIONAL
SDS-plus				10 pieces
Ø mm	L1 mm	L2 mm	€/PU	Item no.
6.0	110	50	23.60	83 06 110 10
6.0	160	100	25.40	83 06 160 10
8.0	160	100	31.90	83 08 160 10
8.0	210	150	39.80	83 08 210 10
8.0	260	200	44.50	83 08 260 10
10.0	160	100	38.40	83 10 160 10
10.0	210	150	46.80	83 10 210 10
12.0	160	110	42.60	83 12 166 10
12.0	210	160	51.10	83 12 216 10
14.0	210	160	69.20	83 14 216 10



Hollow core bits

Including SDS-plus shank and centering drill bit



Ø 68 mm

#015	STANDARD
54166	3 pieces
€	24.50



Ø 82 mm

#016	STANDARD
54180	3 pieces
€	34.50

Hollow core bit set

Ø 68 mm and Ø 82 mm
Including SDS-plus shank, hexagonal shank and two centering drill bits



- Hollow core bits with 8 carbide teeth
- Maximum drilling depth 50 mm
- Thread connection M22

SPECIAL PRICE	#017	STANDARD
	54100	6 pieces
€	54.50	



Chisel sets

Pointed chisel, flat chisel and spade chisel

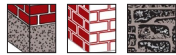

- Dimensions of the chisels can be found in the tables on the right

SDS-plus

#018	STANDARD
99956	3 pieces
€	15.50



SDS-max

#019	STANDARD
844002	3 pieces
€	26.00

Chisel bulk packs

SDS-plus

#020		STANDARD		
SDS-plus		10 pieces		
Description	L mm	W mm	€/PU	Item no.
Pointed chisel	250		33.50	84 106 250 210
Flat chisel	250	20	33.50	84 206 250 210
Spade chisel	250	40	42.00	84 406 250 210

SDS-max

#021		STANDARD		
SDS-max		10 pieces		
Description	L mm	W mm	€/PU	Item no.
Pointed chisel	400		62.00	84 170 400 210
Flat chisel	400	25	62.00	84 270 400 210
Spade chisel	400	50	71.50	84 470 400 210

Floor cleaning tools

NEW

Ideal for removing adhesive residues on screeded concrete



SDS-plus
290 x 130 mm (LxW)

#022	PROFESSIONAL
84906250	1 piece
€	99.50

Replacement plate
for SDS-plus tool

#023	PROFESSIONAL
84906001	1 piece
€	29.90

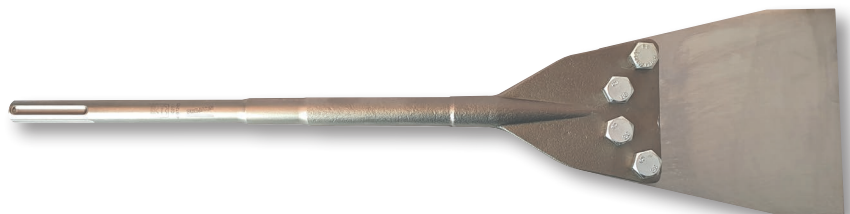

SDS-max
635 x 152 mm (LxW)

#024	PROFESSIONAL
84970630	1 piece
€	179.50

Replacement plate
for SDS-max tool

#025	PROFESSIONAL
84970001	1 piece
€	38.90



STEEL

TWIST DRILL BIT SETS DIN 338 ECO



60001 / 60315 / 60381 / 60005 / 60375 / 60386
Image similar

in metal box



67003 / 67315 / 67381 / 67007 / 67375 / 67386
Image similar

in plastic box



60600 / 60615 / 60613 Image similar

in metal case

HSS-R



- Rollforged for high resistance against breaking forces
- Conical grind
- Point angle 118°

#026				PLUS
Pieces	Content	Packaging	€/PU	Item no.
19	Ø 1 - 10 / 0.5 mm increasing	Metal box	12.50	60001
		Plastic box	15.00	67003
25	Ø 1 - 13 / 0.5 mm increasing	Metal box	26.70	60005
		Plastic box	28.60	67007
170	10x Ø 1.0 - 8.0 / 0.5 mm increasing 5x Ø 8.5 - 10.0 / 0.5 mm increasing	Metal case	86.80	60600

HSS-G



- Ground for high precision and speed
- Split point from Ø 3 mm
- Point angle 135°

#027				PLUS
Pieces	Content	Packaging	€/PU	Item no.
19	Ø 1 - 10 / 0.5 mm increasing	Metal box	18.30	60315
		Plastic box	21.80	67315
25	Ø 1 - 13 / 0.5 mm increasing	Metal box	38.70	60375
		Plastic box	41.20	67375
170	10x Ø 1.0 - 8.0 / 0.5 mm increasing 5x Ø 8.5 - 10.0 / 0.5 mm increasing	Metal case	154.70	60615

HSS-Co 5%



- Cobalt alloy for a high level of heat and wear resistance
- Split point from Ø 3 mm
- Point angle 135°

#028				PLUS
Pieces	Content	Packaging	€/PU	Item no.
19	Ø 1 - 10 / 0.5 mm increasing	Metal box	57.70	60381
		Plastic box	60.60	67381
25	Ø 1 - 13 / 0.5 mm increasing	Metal box	114.90	60386
		Plastic box	117.90	67386
170	10x Ø 1.0 - 8.0 / 0.5 mm increasing 5x Ø 8.5 - 10.0 / 0.5 mm increasing	Metal case	335.00	60613



Outer reamer with carbide blades

Ø 3 - 19 mm
max 500 rpm

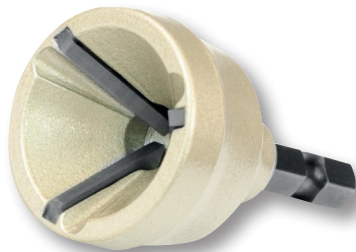

#029 PROFESSIONAL
35401 1 piece
€ 39.50

Ø 13 - 35 mm
max 150 rpm

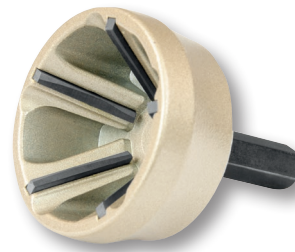

#030 PROFESSIONAL
35402 1 piece
€ 69.00

Ø 34 - 54 mm
max 60 rpm

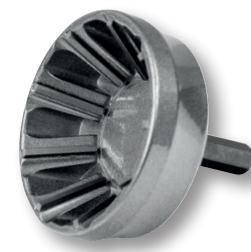

#031 PROFESSIONAL
35403 1 piece
€ 114.50



Carbide burr set

Head Ø 9.6 mm - shank Ø 6.0 mm
Form B - Form C - Form D -
Form E - Form G



- With double cut for a high stock removal rate and smooth milling performance



#032 PROFESSIONAL
70295 5 pieces
€ 82.50

Countersink sets

Ø 6.3 - 8.3 - 10.4 -
12.4 - 16.5 - 20.5 mm



HSS-G

#033 PLUS
35005 6 pieces
€ 44.50

HSS-Co 5%

#034 PLUS
35605 6 pieces
€ 59.50



NEW

Tube and sheet drill bit sets

3 - 14 mm / 8 - 20 mm /
16 - 30.5 mm



HSS-G

#035 PROFESSIONAL
75065 3 pieces
€ 69.50



HSS-Co 5%

#036 PROFESSIONAL
75665 3 pieces
€ 89.50

Step drill bit sets

4 - 12 mm / 6 - 20 mm /
6 - 30 mm

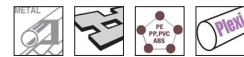

HSS-G

#037 PROFESSIONAL
76811 4 pieces
€ 119.50

HSS-Co 5%

#038 PROFESSIONAL
76911 4 pieces
€ 149.50





THREAD

Thread bundle

Thread bundle (item no. 99989) consisting of tap set (item no. 91013) and circular die set (item no. 91015)

Single-cut tap set (item no. 91013)
7 single-cut taps HSS-G DIN 352
M3 - M4 - M5 - M6 - M8 - M10 - M12
7 core hole drill bits HSS-G DIN 338
Ø 2.5 - 3.3 - 4.2 - 5.0 - 6.8 - 8.5 - 10.2 mm
1 tap wrench No. 1 1/2

Circular die set (item no. 91015)
7 circular dies HSS-G
M3 - M4 - M5 - M6 - M8 - M10 - M12
1 die stock



Item no. 91013



Item no. 91015

#039	STANDARD
91013	15 pieces
€	25.20

#040	STANDARD
91015	8 pieces
€	29.40

#041	STANDARD
99989	23 pieces
SPECIAL PRICE	€ 49.90

Combined machine drill tap set



6 combined machine drill taps HSS-G 6.35 mm [1/4"]
M3 - M4 - M5 - M6 - M8 - M10
1 bit holder

- Core hole drilling, thread cutting and deburring in one operation

#042	PLUS
91019	7 pieces
€	48.50

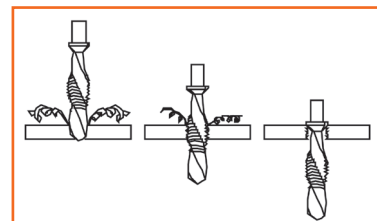

Machine tap sets



7 machine taps DIN 371/376
M3 - M4 - M5 - M6 - M8 - M10 - M12
7 core hole drill bits DIN 338
Ø 2.5 - 3.3 - 4.2 - 5.0 - 6.8 - 8.5 - 10.2 mm

HSS-G for through holes

#043	STANDARD
91030	14 pieces
€	44.90

HSS-G for blind holes

#045	STANDARD
91040	14 pieces
€	46.50

HSS-Co 5% for through holes

#044	STANDARD
91031	14 pieces
€	79.50

HSS-Co 5% for blind holes

#046	STANDARD
91041	14 pieces
€	83.50



91030 / 91031 Image similar



91040 / 91041 Image similar



Taps and dies set



- 21 hand taps HSS DIN 352
- 1 set each (taper, plug and bottoming tap)
- M3 - M4 - M5 - M6 - M8 - M10 - M12
- 7 circular dies HSS-G
- M3 - M4 - M5 - M6 - M8 - M10 - M12
- 7 core hole drill bits HSS-G DIN 338
- Ø 2.5 - 3.3 - 4.2 - 5.0 - 6.8 - 8.5 - 10.2 mm
- 1 die stock
- 1 tap wrench No. 1 1/2
- 1 tool holder No. 1
- 1 screwdriver (item no. 91508)
- 1 screw pitch gauge (item no. 915091)

#047	STANDARD
91009	40 pieces
€ 114.⁵⁰	



Taps and dies set



- 21 hand taps HSS DIN 352
- 1 set each (taper, plug and bottoming tap)
- M3 - M4 - M5 - M6 - M8 - M10 - M12
- 7 circular dies DIN EN 22568
- M3 - M4 - M5 - M6 - M8 - M10 - M12
- 7 core hole drill bits HSS-G DIN 338
- Ø 2.5 - 3.3 - 4.2 - 5.0 - 6.8 - 8.5 - 10.2 mm
- 5 die stocks
- 20x5 - 20x7 - 25x9 - 30x11 - 38x14 mm
- 2 tap wrenches No. 1 + 2
- 1 screwdriver (item no. 91508)
- 1 screw pitch gauge (item no. 915091)

#048	STANDARD
91004	44 pieces
€ 149.⁵⁰	



Taps and dies set



- 33 hand taps HSS DIN 352
- 1 set each (taper, plug and bottoming tap)
- M3 - M4 - M5 - M6 - M8 - M10 - M12 - M14 - M16 - M18 - M20
- 11 circular taps DIN EN 22568
- M3 - M4 - M5 - M6 - M8 - M10 - M12 - M14 - M16 - M18 - M20
- 6 die stocks
- 20x5 - 20x7 - 25x9 - 30x11 - 38x14 - 45x18 mm
- 2 tap wrenches No. 1 1/2 + 3
- 1 screwdriver (item no. 91508)
- 1 screw pitch gauge (item no. 915091)
- 1 tool holder with ratchet (item no. 913011)

#049	STANDARD
91005	55 pieces
€ 289.⁵⁰	





OSCILLATING MULTI-TOOLS

Wood

NEW

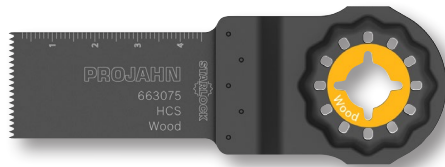

#050		PROFESSIONAL			
Width x cutting depth	Teeth distance	Material	Pieces per PU	€/PU	Item no.
24 x 48 mm	1.3 mm	Bi-metal	1	6.90	663 071
			5	29.90	663 075

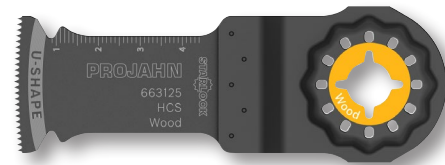

#051		PROFESSIONAL			
Width x cutting depth	Teeth distance	Material	Pieces per PU	€/PU	Item no.
32 x 50 mm	1.4 mm	Bi-metal	1	9.80	663 121
			5	42.50	663 125
			20	149.50	6 631 220

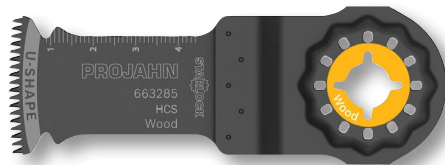

#052		PROFESSIONAL			
Width x cutting depth	Teeth distance	Material	Pieces per PU	€/PU	Item no.
32 x 50 mm	1.8 mm	HCS	1	9.80	663 281
			5	42.50	663 285
			20	149.50	6 632 820

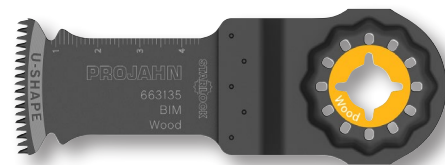

#053		PROFESSIONAL			
Width x cutting depth	Teeth distance	Material	Pieces per PU	€/PU	Item no.
32 x 50 mm	1.8 mm	Bi-metal	1	13.50	663 131
			5	57.50	663 135
			20	199.50	6 631 320

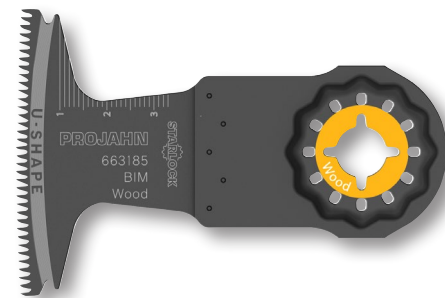

#054		PROFESSIONAL			
Width x cutting depth	Teeth distance	Material	Pieces per PU	€/PU	Item no.
65 x 40 mm	1.8 mm	Bi-metal	1	15.50	663 181
			5	68.50	663 185
			20	235.00	6 631 820

Metal

NEW

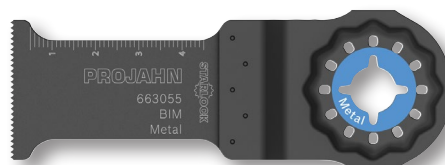

#055		PROFESSIONAL			
Width x cutting depth	Teeth distance	Material	Pieces per PU	€/PU	Item no.
32 x 50 mm	1.3 mm	Bi-metal	1	12.50	663 051
			5	53.50	663 055
			20	190.00	6 630 520

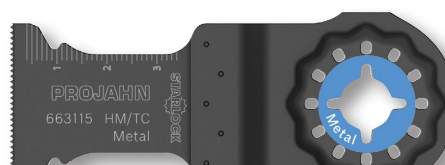

#056		PROFESSIONAL			
Width x cutting depth	Teeth distance	Material	Pieces per PU	€/PU	Item no.
32 x 40 mm	1.1 mm	Carbide	1	21.90	663 111
			5	94.50	663 115



OSCILLATING MULTI-TOOLS

Wood and Metal

NEW

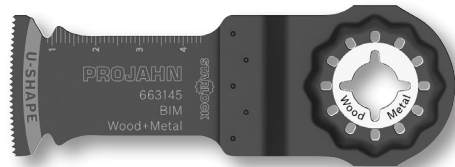

#057		PROFESSIONAL			
Width x cutting depth	Teeth distance	Material	Pieces per PU	€/PU	Item no.
32 x 50 mm	1.3 mm	Bi-metal	1	13.50	663 141
			5	57.50	663 145
			20	199.50	6 631 420

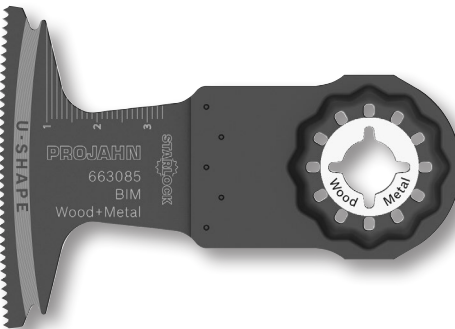

#058		PROFESSIONAL			
Width x cutting depth	Teeth distance	Material	Pieces per PU	€/PU	Item no.
65 x 40 mm	1.3 mm	Bi-metal	1	17.00	663 081
			5	75.00	663 085
			20	255.00	6 631 820



- Ø 85 mm
- Tooth distance 1.4 mm
- Bi-metal

#059 **PROFESSIONAL**
66301 1 piece
 € **19.90**



Mortar



- Ø 85 mm
- Thickness approx. 2.5 mm
- Carbide grains

#060 **PROFESSIONAL**
66318 1 piece
 € **25.50**

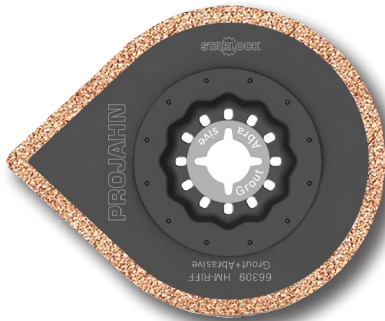

- Ø 70 mm
- Thickness approx. 2.0 mm
- Carbide grains

#061 **PROFESSIONAL**
66309 1 piece
 € **39.90**

Multi Material



- Cutting width 52 mm

#062 **PROFESSIONAL**
66310 1 piece
 € **9.60**



- Cutting on pull or push

#063 **PROFESSIONAL**
66317 1 piece
 € **17.90**



SAWS

Saber saw blade

- Longer lifetime due to induction-hardened tooth tips
- Teeth/inch: 6
- Toothed length: 245 mm

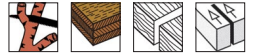

#064 PROFESSIONAL
64296 2 pieces
€ **28.50**



Saber saw blades

- Carbide tothing ensures maximum lifetime
- Teeth/inch: 8



Toothed length:
130 mm

SPECIAL PRICE #065 PROFESSIONAL
64321 1 piece
€ **17.90**

Toothed length:
205 mm

SPECIAL PRICE #066 PROFESSIONAL
64322 1 piece
€ **26.50**

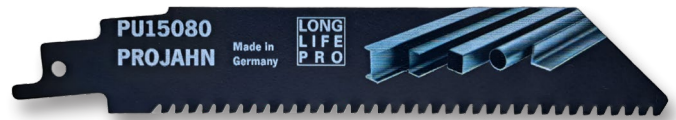

Jigsaw blade set for wood

Fine, rough, clean, fast and curved cuts in wood and plastics

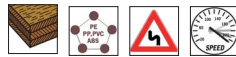

#067 PROFESSIONAL
63001 10 pieces
€ **12.50**

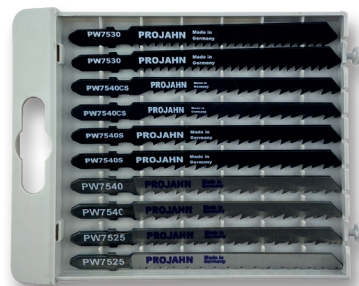

Jigsaw blade set for metal

Fast and precise cuts in sheet metal, metal tubes and profiles with a material thickness of 1.2 mm to 15.0 mm

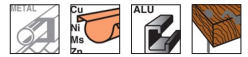

#068 PROFESSIONAL
63002 10 pieces
€ **15.90**



Bi-metal hole saw set

Ø 19 - 22 - 25 - 29 - 32 - 35 - 44 - 51 - 57 - 60 - 68 - 76 mm
Including Quick-Lock adapter 14 - 30 mm and 32 - 210 mm
2x HSS centering drill bits and 1x hex key

- 38 mm cutting depth



#069 PROFESSIONAL
68912 14 pieces
€ **129.50**





Wood drill bit set

Ø 3 - 10 mm / 1 mm increasing

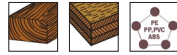

- Center point and two shouldered cutting edges ensure pin-point center-drilling and precise drill holes
- Suitable for softwood, plywood, chip-boards and plastics



#070 **STANDARD**
67040 8 pieces
€ **8.30**

Flat wood drill bit set

Ø 6 - 8 - 10 - 12 - 13 - 14 - 16 - 18 - 19 - 20 - 22 - 24 - 25 mm

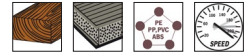

- Flat drill bit with center point, two cutting edges and 6.3 [1/4"] hex shank
- With ground basic and main cutting edges
- Length 152 mm



#071 **PLUS**
19698 13 pieces
€ **24.50**

Router bit set

Bevel trim bit Ø 28.6 mm
Round over bit Ø 24.7 + 32.7 mm
Cove bit Ø 22.0 + 28.5 mm
Roman ogee bit Ø 35.0 mm
Groove cutter Ø 8.0 + 16.0 mm
Flush trim bit Ø 12.7 mm
Core box cutter Ø 12.0 mm
Dovetail bit Ø 14.3 mm
Engraving cutter Ø 11.0 mm



- Shank diameter 8 mm



#072 **PLUS**
19299 12 pieces
€ **62.50**

Carbide tipped hole saw set

Ø 19 - 22 - 25 - 32 - 35 - 40 - 44 - 51 - 57 - 64 - 68 - 76 mm
Including Quick-Lock adapter
14 - 30 mm and 32 - 210 mm
1x TCT + 2x HSS centering drill bits and hex key



- Cutting depth approx. 55 mm



#073 **PLUS**
60591 18 pieces
€ **139.50**

Forstner drill bit sets

- Precise and splinter-free drilling in wood
- With center point, 2 main and peripheral cutting edges
- Designed to drill: hard wood, soft wood and veneered wooden board



Ø 10 - 12 - 15 - 16 - 18 - 20 - 22 - 25 - 26 - 28 - 30 - 35 - 40 - 45 - 50 mm

Ø 15 - 20 - 25 - 30 - 35 mm

#074 **PLUS**
33002-1 15 pieces
€ **83.90**

#075 **PLUS**
33001-1 5 pieces
€ **21.90**



Item no. 33002-1



Item no. 33001-1



TOOL CASES

EQUIPPED TOOL CASES

Universal

- 1/4" - 5/16" - 1/2"
- 1/4" and 1/2" reversible ratchet with rough tothing
- 12 sockets 1/4" 4 - 13 mm and 14 sockets 1/2" 10 - 32 mm
- Robust, break-proof and lockable case

#076	PLUS
8681	149 Pieces
€ 269. ⁰⁰	



Universal Compact

- 1/4" - 3/8"
- 3/8" reversible ratchet with rough tothing
- 17 sockets 3/8" 6 - 24 mm
- Robust, break-proof and lockable case

#077	PLUS
8682	164 Pieces
€ 219. ⁰⁰	



Universal Trolley

- 1/4" - 1/2"
- 1/4" and 1/2" reversible ratchet with rough tothing
- 12 sockets 1/4" 4 - 13 mm and 16 sockets 1/2" 10 - 32 mm
- Sturdy and lockable ABS trolley with automatic locking telescopic handle

#078	PLUS
4963-01	131 Pieces
€ 339. ⁰⁰	





EQUIPPED TOOL CASES

Electrician

- 1/4" - 1/2"
- 1/4" and 1/2" reversible ratchet with rough tothing
- 12 sockets 1/4" 4 - 13 mm and 12 sockets 1/2" 10 - 22 mm
- Content tailored to the electrical craft

#079	PLUS
8683	128 Pieces
€ 269. ⁰⁰	



Carpenter

- 1/4"
- Content tailored to the carpentry craft
- Ideal for craftsmen, fitters or apprentices
- Robust, break-proof and lockable case

#080	PLUS
8684	96 Pieces
€ 229. ⁰⁰	



Plumber

- 1/4" - 1/2"
- Reversible ratchet for 1/2" square drive
- 13 sockets 1/2" 10 - 24 mm
- Content tailored to the plumbing craft

#081	PLUS
8685	98 Pieces
€ 335. ⁰⁰	





SOCKET SETS

Socket set

- 1/4"
- 1/4" reversible ratchet with rough or fine tothing
- 13 sockets 1/4" 4 - 14 mm
- 1/4" bit sockets for all main applications

8651 Rough, 48 teeth
8652 Fine, 72 teeth

#082	STANDARD
46 Pieces	
€	37.50



Socket set

- 1/2"
- 1/2" reversible ratchet with rough or fine tothing
- 15 sockets 1/2" 10 - 32 mm
- Including spark plug sockets 1/2" 16 + 21 mm

8661 Rough, 48 teeth
8662 Fine, 72 teeth

#083	STANDARD
22 Pieces	
€	63.50



Socket set

- 1/4" - 5/16" - 1/2"
- 1/4" and 1/2" reversible ratchet with rough or fine tothing
- Sockets 4 - 32 mm and E-TX sockets E4 - E22
- 1/4" bit sockets for all main applications

8653 Rough, 48 teeth
8654 Fine, 72 teeth

#084	STANDARD
108 Pieces	
€	115.00





Socket set

- 1/4" - 5/16" - 3/8" - 1/2"
- 1/4", 3/8" and 1/2" reversible ratchet with rough or fine toothing
- Sockets 4 - 32 mm and E-TX sockets E4 - E24
- 1/4" bit sockets for all main applications

8663 Rough, 48 teeth
8664 Fine, 72 teeth

#085	STANDARD	Details
	182 Pieces	
€ 129.00		



Universal tool sets

- 1/4" - 1/2" - 10 mm
- 1/4" and 1/2" reversible ratchet with rough or fine toothing
- Combination wrench 8 - 19 mm, hammer, sockets 4 - 24 mm and high-quality bit set
- Ideal for caretakers and building technicians

8665 Rough, 48 teeth
8666 Fine, 72 teeth

SPECIAL PRICE

#086	STANDARD	Details
	98 Pieces	
€ 139.00		



Toolbox UNIVERSAL



#087	PLUS	Details
8688	84 Pieces	
€ 244.00		

- 1/4" - 1/2"
- 1/2" reversible ratchet with rough toothing
- 14 sockets 1/2" 10 - 32 mm
- Incl. spark plug sockets 16 + 21 mm

Empty Toolbox



#088	PLUS
8688K	
€ 58.00	

- Robust and shock-proof metal box for individual tool storage



WORKSHOP TROLLEY

Workshop trolley UNIVERSE, empty

Material: sheet steel, powder-coated
 Material thickness: 0.9 - 1.0 mm
 Height x width x depth: 1,020 x 628 (775 incl. handle) x 475 mm
 Total load capacity: 650 kg (static)
 Load capacity/drawer: 45 kg
 Height of drawers: 2 x 154 mm / 5 x 75 mm
 Castor dimensions (Ø x W): 127 x 50 mm



- Extremely high stability and torsional rigidity due to double wall construction
- Optionally with 240 Volt connector strip (double) incl. two USB charging ports
- Expandable by top cases and accessories

#089 PROFESSIONAL
BASIC VERSION
€ 769.00

- 6501-50
- 6501-10

#090 PROFESSIONAL
E-POWER VERSION
€ 799.00

- 6501-51
- 6501-11

Workshop trolley SPACE, empty

Material: sheet steel, powder-coated
 Material thickness: 0.8 - 0.9 mm
 Height x width x depth: 990 x 910 (990 incl. handle) x 475 mm
 Total load capacity: 500 kg (static)
 Load capacity/drawer: 40 kg
 Height of drawers: 2 x 154 mm / 5 x 75 mm
 Castor dimensions (Ø x W): 127 x 50 mm

- Huge capacity
- Large storage compartments in 2 additional side doors
- Larger work and shelf space and more space for your tools

#091 PLUS
7901-50
€ 679.00

-



Workshop trolley GALAXY, empty

Material: sheet steel, powder-coated
 Material thickness: 0.8 mm
 Height x width x depth: 980 x 678 (775 incl. handle) x 459 mm
 Total load capacity: 450 kg (static)
 Load capacity/drawer: 40 kg
 Height of drawers: 2 x 154 mm / 5 x 75 mm
 Castor dimensions (Ø x W): 127 x 50 mm

- Easy reachability of the tools due to 100% fully extendable drawers
- Expandable by top cases and accessories
- Can be complemented with a wide range of accessories due to perforated sheet metal wall

#092 PLUS
5501-50
€ 499.00

- 5501-50
- 5501-20
- 5501-10





Workshop trolley STAR, empty

Material: sheet steel, powder-coated
 Material thickness: 0.8 mm
 Height x width x depth: 1,010 x 676 (678 incl. handle) x 459 mm
 Total load capacity: 400 kg (static)
 Drawer quantity: 6
 Load capacity/drawer: 35 kg
 Height of drawers: 3 x 154 mm / 3 x 75 mm
 Castor dimensions (Ø x W): 127 x 32 mm

- Stable handle, mountable on both sides
- Only-One-Drawer-System: only one drawer can be opened at a time
- Wheels with roller and swivel brake



#093 STANDARD
 4901-50
€ 399.00

Workshop trolleys with 229 pieces equipment PROFICRAFT

- Universal tooling for 3 drawers
- With 3 stable and high quality 72-tooth fine-tooth ratchets

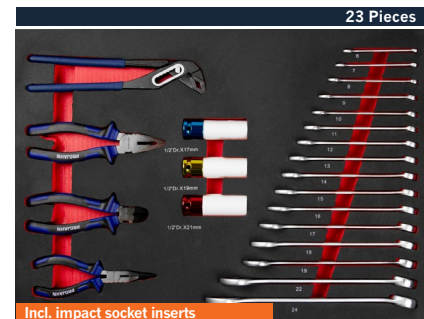
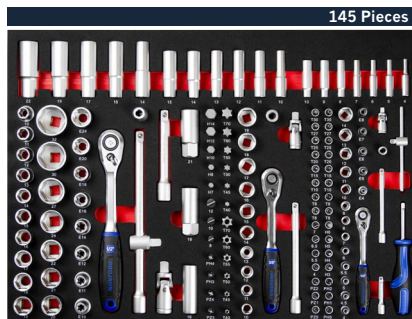

Workshop trolley STAR



#094 STANDARD
 4901-591 229 Pieces
€ 669.00

Workshop trolley GALAXY



#095 PLUS
 5501-591 229 Pieces
€ 769.00

- 5501-591
- 5501-291
- 5501-191



WORKSHOP TROLLEY

EQUIPMENT FOR WORKSHOP TROLLEYS

171-piece assembly for 3 drawers

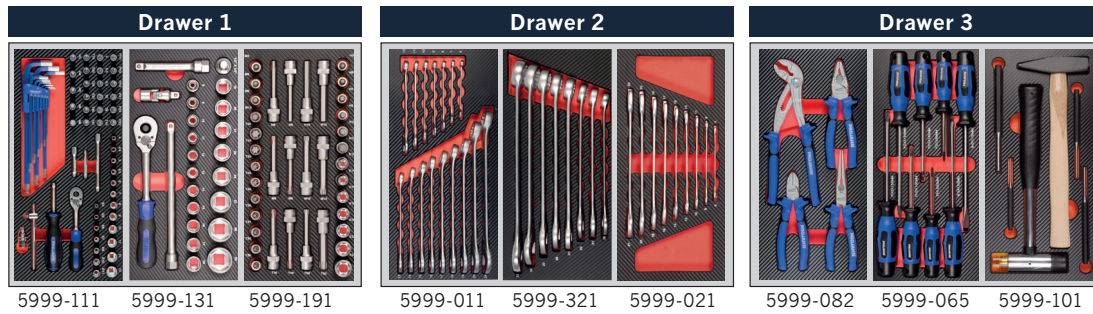

#096
5995-011 171 Pieces
€ 699.00

187-piece assembly for 4 drawers



#097
5995-024 187 Pieces
€ 799.00

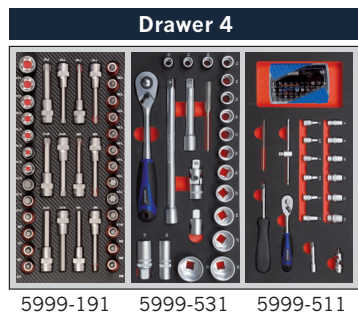

2x Xi-on inlays
+
bit set 394089

320-piece assembly for 5 drawers

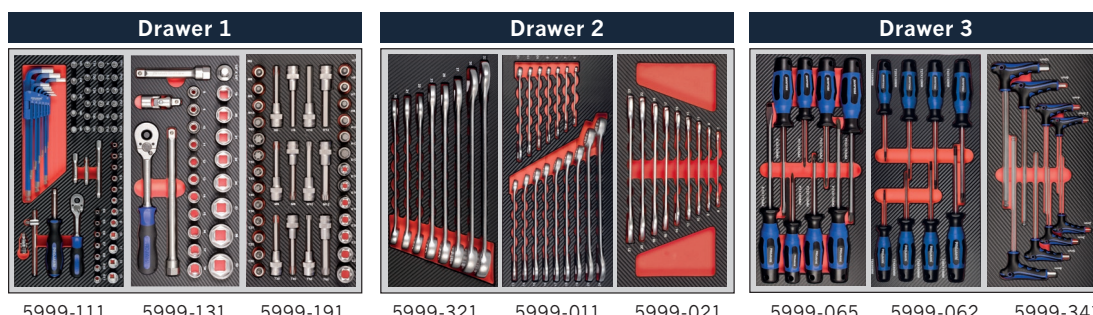

#098
5995-141 320 Pieces
€ 899.00





EQUIPPED WORKSHOP TROLLEYS

UNIVERSE



Can't find the right combination? Take a look at the PROJAHN workshop trolley brochure for further options and suitable accessories!



#099		PROFESSIONAL	
Content	Color	€/PU	Item no.
171 Pieces	red	1,399.00	6501-111
	blue	1,399.00	6501-511
187 Pieces	red	1,499.00	6501-124
	blue	1,499.00	6501-524
320 Pieces	red	1,599.00	6501-141
	blue	1,599.00	6501-541

GALAXY



#100		PLUS	
Content	Color	€/PU	Item no.
171 Pieces	red	1,099.00	5501-111
	blue	1,099.00	5501-511
	black	1,099.00	5501-211
187 Pieces	red	1,199.00	5501-124
	blue	1,199.00	5501-524
	black	1,199.00	5501-224
320 Pieces	red	1,299.00	5501-141
	blue	1,299.00	5501-541
	black	1,299.00	5501-241

SPACE



#101		PLUS	
Content	Color	€/PU	Item no.
171 Pieces	blue	1,279.00	7901-511
187 Pieces	blue	1,379.00	7901-524
320 Pieces	blue	1,479.00	7901-541

STAR



#102		STANDARD	
Content	Color	€/PU	Item no.
171 Pieces	blue	999.00	4901-511
187 Pieces	blue	1,099.00	4901-524
320 Pieces	blue	1,199.00	4901-541



WRENCHES

WRENCH SETS

Combination wrench

NEW

SPECIAL PRICE
#103 **STANDARD**
4471 8 Pieces
€ **13.90**



8 - 9 - 10 - 11 - 13 - 14 - 17 - 19 mm

SPECIAL PRICE
#105 **STANDARD**
4473 14 Pieces
€ **19.90**

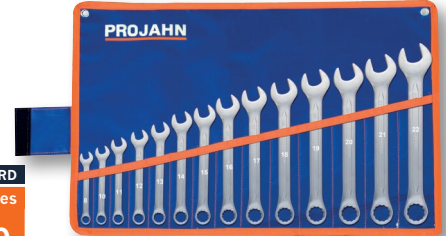

8 - 10 - 11 - 12 - 13 - 14 - 15 - 16 - 17 - 18 - 19 - 20 - 21 - 22 mm

SPECIAL PRICE
#104 **STANDARD**
4472 12 Pieces
€ **15.90**

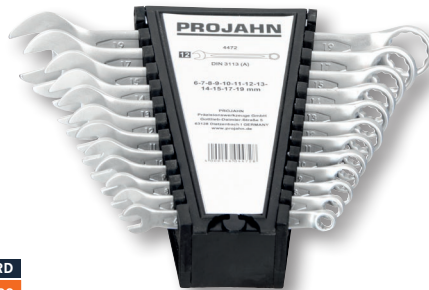

6 - 7 - 8 - 9 - 10 - 11 - 12 - 13 - 14 - 15 - 17 - 19 mm

SPECIAL PRICE
#106 **STANDARD**
4474 25 Pieces
€ **49.90**



6 - 7 - 8 - 9 - 10 - 11 - 12 - 13 - 14 - 15 - 16 - 17 - 18 - 19 - 20 - 21 - 22 - 23 - 24 - 25 - 26 - 27 - 28 - 30 - 32 mm

Double open end wrench

NEW

SPECIAL PRICE
#107 **STANDARD**
4475 8 Pieces
€ **12.90**



6 x 7 - 8 x 9 - 10 x 11 - 12 x 13 - 14 x 15 - 16 x 17 - 18 x 19 - 20 x 22 mm

SPECIAL PRICE
#108 **STANDARD**
4476 11 Pieces
€ **29.90**



6 x 7 - 8 x 9 - 10 x 11 - 12 x 13 - 14 x 15 - 16 x 17 - 18 x 19 - 20 x 22 - 21 x 23 - 24 x 27 - 30 x 32 mm

SCAFFOLDING RATCHET 19 X 22 MM

- With switch for quick change of ratchet direction
- Tapered handle allows quick adjusting of elements
- Two-sided ratchet with special hardened sockets

SPECIAL PRICE
#109 **STANDARD**
231922
€ **25.00**





GEARTECH RATCHET WRENCHES SETS

Classic

8 - 10 - 12 - 13 - 16 -
17 - 18 - 19 mm

#110 **PROFESSIONAL**
3499 **8 Pieces**
€ **54.00**



6 - 7 - 8 - 9 - 10 - 11 -
12 - 13 - 14 - 15 - 16
- 17 - 18 - 19 mm

#111 **PROFESSIONAL**
3494 **14 Pieces**
€ **95.00**

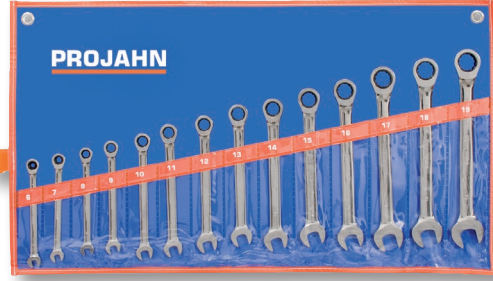

Reversible

8 - 10 - 12 - 13 - 16 -
17 - 18 - 19 mm

#112 **PROFESSIONAL**
3999 **8 Pieces**
€ **75.00**



6 - 7 - 8 - 9 - 10 - 11 -
12 - 13 - 14 - 15 - 16
- 17 - 18 - 19 mm

#113 **PROFESSIONAL**
3994 **14 Pieces**
€ **130.00**



Flexible

8 - 10 - 12 - 13 - 16 -
17 - 18 - 19 mm

#114 **PROFESSIONAL**
3497 **8 Pieces**
€ **79.00**



6 - 7 - 8 - 9 - 10 - 11 -
- 12 - 13 - 14 - 15 - 16 -
17 - 18 - 19 mm

#115 **PROFESSIONAL**
3493 **14 Pieces**
€ **135.00**



4-IN-1 SCAFFOLDING RATCHET 19 X 22 MM

- Versatile due to 4 functions
- Forged hammer
- Movable pry bar
- Reversible ratchet
- Pointed cone

SPECIAL PRICE
#116 **PLUS**
2319221
€ **29.00**

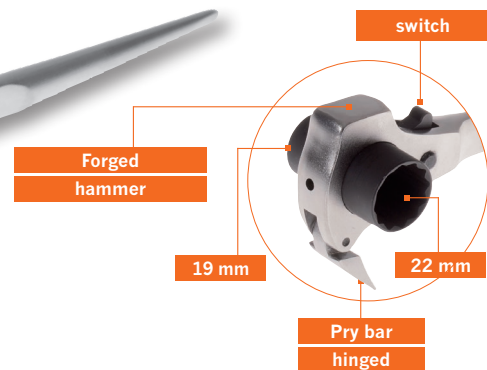



POWER-LED FLASHLIGHTS

Flashlight PJ2000

NEW

Light Power: 2000 Lumen
 Light Distance: 240 m
 Fluorescent Time: approx. 4.5 hours
 Protection Class: IP 54 splash water protected
 Batteries: 3.7 V 4000 mAh lithium-ion-battery, rechargeable
 Or 3 x AAA

Incl. rechargeable battery, battery holder and USB-C charging cable

- 5 light modes selectable via switch
- Focusable



#117 PROFESSIONAL
 398200
 € 29.⁹⁰

Flashlight PJ500

Light Power: 500 Lumen
 Light Distance: 300 m
 Fluorescent Time: approx. 8 hours
 Protection Class: IP 67 waterproof
 Batteries: 3x C-Cell (inklusive)

- Continuously dimmable



#118 PROFESSIONAL
 398215
 € 28.⁵⁰

Flashlight PJ150

NEW

Light Power: 150 Lumen
 Light Distance: 75 m
 Fluorescent Time: approx. 3 hours
 Protection Class: IP 54 splash water protected
 Batteries: 1x AA (inclusive)

- 2 light modes selectable via switch
- Focusable



#119 PROFESSIONAL
 398213
 € 11.⁹⁰

Flashlight PJ120

Light Power: 120 Lumen
 Light Distance: 65 m
 Fluorescent Time: approx. 2.5 hours
 Protection Class: IP 54 splash water protected
 Batteries: 2x AA (inclusive)

- 2 light modes selectable via switch
- Focusable



#120 PROFESSIONAL
 398211
 € 14.⁹⁰

Penlight PJ140

NEW

Light Power: 140 Lumen
 Light Distance: 80 m
 Fluorescent Time: approx. 6 hours
 Protection Class: IP 54 splash water protected
 Batteries: 2x AAA (inclusive)

- With clip - for jacket and waistcost pocket



#121 PROFESSIONAL
 398216
 € 9.⁹⁰



Working lamp PJ-HL1300

Light Power: 1000 Lumen
 Light Distance: 100 m
 Fluorescent Time: Up to 12 hours
 Protection Class: IP 65 jet water protected
 Batteries: 3.7 V 2500 mAh lithium-ion-battery, rechargeable
 Incl. battery and USB-C charging cable

- 4 light modes selectable via switch
- 150° adjustable magnetic base



NEW

#122 PROFESSIONAL
 398253
 € **22.⁹⁰**

Working lamp PJ-HL1200

Light Power: 1000 Lumen
 Light Distance: 100 m
 Fluorescent Time: Up to 12 hours
 Protection Class: IP 65 jet water protected
 Batteries: 3.7 V 4400 mAh lithium-ion-battery, rechargeable
 Incl. battery and USB-C charging cable

- 4 light modes selectable via switch
- Magnetic stand and 2 magnets on the backside

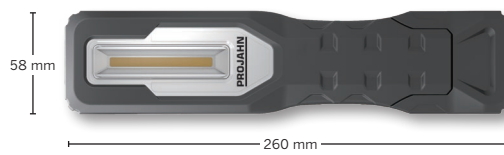

NEW

#123 PROFESSIONAL
 398254
 € **34.⁹⁰**

Headlamp PJ100S

Light Power: 100 Lumen
 Light Distance: 50 m
 Fluorescent Time: approx. 6 hours
 Protection Class: IP 54 splash water protected
 Batteries: 3x AAA (inclusive)

- 3 light modes selectable via switch
- 90° inclinable



#124 PROFESSIONAL
 398230
 € **13.⁹⁰**

Headlamp PJ-SL400

Light Power: 400 Lumen
 Light Distance: 120 m
 Fluorescent Time: Up to 6 hours
 Protection Class: IP 65 jet water protected
 Batteries: 3.7 V 1200 mAh lithium-ion-battery, rechargeable
 Incl. battery and USB-C charging cable

- 4 light modes selectable via switch
- 90° inclinable



NEW

#125 PROFESSIONAL
 398232
 € **19.⁹⁰**





BIT SETS

1/4" Color bit set

25 mm

- 2 SL 4 - 5 mm
- 4 PH 1 - 2 - 2 - 3
- 4 PZ 1 - 2 - 2 - 3
- 7 TX 10 - 15 - 20 - 25 - 27 - 30 - 40
- 7 TTX 10 - 15 - 20 - 25 - 27 - 30 - 40
- 6 HEX 2 - 2.5 - 3 - 4 - 5 - 6 mm
- 1
- 1 60 mm
- 1 4288

#126 PROFESSIONAL
4095 33 Pieces
€ 29.00



1/4" Compact socket and bit set

25 mm

- 2 SL 4.5 - 6.5 mm
- 3 PH 1 - 2 - 3
- 3 PZ 1 - 2 - 3
- 7 TTX 10 - 15 - 20 - 25 - 27 - 30 - 40
- 6 HEX 2 - 2.5 - 3 - 4 - 5 - 6 mm
- 10 5.5 - 6 - 7 - 8 - 9 - 10 - 11 - 12 - 13 - 14 mm
- 2 50 + 100 mm
- 1
- 1
- 2

#127 PROFESSIONAL
394072 38 Pieces
€ 49.00



1/4" TX bit set

NEW

25 mm

- TX 10 - 15 - 2x20 - 2x25 - 27 - 30 - 40 - 45
- 1 60 mm

#128 PLUS
394011 11 Pieces
€ 8.90



1/4" Impact TX bit set

NEW

25 mm

- TX 10 - 2x15 - 2x20 - 2x25 - 27 - 30 - 40
- 1 65 mm



#129 PROFESSIONAL
394012 11 Pieces
€ 9.90





1/4" bit set PROFICRAFT

NEW

25 mm

- 2 SL 4 - 5 mm
- 4 PH 1 - 2 - 2 - 3
- 4 PZ 1 - 2 - 2 - 3
- 7 TX 10 - 15 - 20 - 25 - 27 - 30 - 40
- 7 TTX 10 - 15 - 20 - 25 - 27 - 30 - 40
- 6 HEX 2 - 2.5 - 3 - 4 - 5 - 6 mm
- 1 60 mm
- 1 60 mm

#130	STANDARD
3953001	32 Pieces
€	8.³⁹



1/4" Bit and socket set

25 mm

- 2 SL 5.5 - 6.5 mm
- 5 PH 1 - 2 - 2 - 2 - 3
- 5 PZ 1 - 2 - 2 - 2 - 3
- 3 HEX 4 - 5 - 6 mm
- 7 TX 10 - 15 - 20 - 25 - 27 - 30 - 40
- 4 7 - 8 - 10 - 13 mm | 65 mm
- 4 M6 - 8 - 10 - 12 | 50 mm
- 1 50 mm

#131	STANDARD
3791	31 Pieces
€	34.⁹⁰



1/4" SECURI bit set



#132	STANDARD
3787	100 Pieces
€	13.⁵⁰

1/4" SECURI bit set



#133	STANDARD
3789	122 Pieces
€	28.⁵⁰

1/4" bit set



#134	STANDARD
3788	36 Pieces
€	17.⁵⁰

1/4" bit set XXL



#135	STANDARD
8606	200 Pieces
€	49.⁹⁰



BITS

Impact bits 1/4"

NEW



- Especially suitable for use with impact wrenches
- Special impact zone diverts the impact into the bit
- Colored rings make it easy to find the right bit



#137		PROFESSIONAL	
For hexagon screws		Pack of 3	
Size	Length	€/PU	Item no.
3 mm	25 mm	4.98	1 790 503-03
4 mm	25 mm	4.98	1 790 504-03
5 mm	25 mm	4.98	1 790 505-03
6 mm	25 mm	4.98	1 790 506-03



#139		PROFESSIONAL	
For TX screws		Pack of 3	
Size	Length	€/PU	Item no.
T10	25 mm	4.49	1 790 310-03
T15	25 mm	4.49	1 790 315-03
T20	25 mm	4.49	1 790 320-03
T25	25 mm	4.49	1 790 325-03
T27	25 mm	4.49	1 790 327-03
T30	25 mm	4.49	1 790 330-03
T40	25 mm	4.49	1 790 340-03
T10	75 mm	7.83	1 791 310-03
T15	75 mm	7.83	1 791 315-03
T20	75 mm	7.83	1 791 320-03
T25	75 mm	7.83	1 791 325-03
T27	75 mm	7.83	1 791 327-03
T30	75 mm	7.83	1 791 330-03
T40	75 mm	7.83	1 791 340-03

Impact bit holder 1/4"

NEW

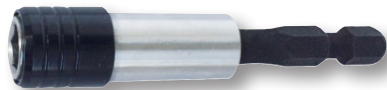

- Especially suitable for use with impact wrenches
- With quick-release chuck for firm locking of the bit
- With permanent magnet - steel screws adhere to the bit

#141	PROFESSIONAL
2768	
€	8. ⁷⁰



#136		PROFESSIONAL	
For Phillips screws		Pack of 3	
Size	Length	€/PU	Item no.
PH1	25 mm	4.98	1 790 001-03
PH2	25 mm	4.98	1 790 002-03
PH3	25 mm	4.98	1 790 003-03
PH1	75 mm	7.83	1 791 001-03
PH2	75 mm	7.83	1 791 002-03
PH3	75 mm	7.83	1 791 003-03



#138		PROFESSIONAL	
For Pozidriv screws		Pack of 3	
Size	Length	€/PU	Item no.
PZ1	25 mm	4.98	1 790 101-03
PZ2	25 mm	4.98	1 790 102-03
PZ3	25 mm	4.98	1 790 103-03
PZ1	75 mm	7.83	1 791 101-03
PZ2	75 mm	7.83	1 791 102-03
PZ3	75 mm	7.83	1 791 103-03



#140		PROFESSIONAL	
For tamper TX screws		Pack of 3	
Size	Length	€/PU	Item no.
T10	25 mm	4.98	1 790 410-03
T15	25 mm	4.98	1 790 415-03
T20	25 mm	4.98	1 790 420-03
T25	25 mm	4.98	1 790 425-03
T27	25 mm	4.98	1 790 427-03
T30	25 mm	4.98	1 790 430-03
T40	25 mm	4.98	1 790 440-03

2-in-1 bit and socket holder 1/4"

NEW



- Useful holder replaces two adapters in one tool
- Can be used as a bit holder or socket adapter by sliding the sleeve
- Suitable for 1/4" bits and 1/4" sockets

#142	PROFESSIONAL
2791	
€	8. ⁹⁰



TOOLS LIKE YOU:

Our tools around the drill hole are for you. Functionality and precision made into tools that are just like you.



About us:

PROJAHN is an owner-managed company for professional tools. For more than 50 years, we have been developing, producing and procuring what professional craftsmen need for their projects.

Our product range consists of over 10,000 items relating to precision and hand tools for drilling and driving. Our hammer drill bits in particular, which we produce ourselves, have a reputation for the highest quality and reliability.

We have our roots in Germany, but we always had an international focus. Over 3,000 dealers and thousands of professionals from trade and industry around the world rely on PROJAHN products. We stand for pioneering services: Application- and future-orientated products, individual support and comprehensive services.

All our products are geared towards the requirements of professional craftsmen, their tasks and challenges. We know that good tools contribute to good work: they increase performance and make work more fun.

At our headquarters in Dietzenbach near Frankfurt am Main, we are a team of over 80 employees. Our efficient logistics centre is also located there. From here, we deliver tools all over the world. Within Germany, we guarantee fast delivery within 24 hours.

PROJAHN stands for quality, service, efficiency and innovation. Our dedicated employees are our best tools. They make PROJAHN into PROJAHN.

If you stop improving, you stop being good. What can we do better? We are looking forward to your feedback: feedback@projahn.de

Your PROJAHN Retailer

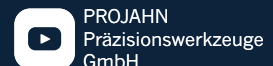
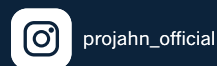

142

Performance specifications, features, pictures, lists, dimensions and weight of products may change in the course of technical development and, due to adaptations to our customers' needs, without any obligation or prior notice. There is no obligation to change earlier deliveries accordingly. We are entitled to remove items from our product range. The offers in this promotion leaflet are not combinable with others. Sales only through specialized trade dealers. Errors and omissions as well as colour variations are subject to change. On account of limited stock some articles may already be sold out.

© 2024 PROJAHN Präzisionswerkzeuge GmbH, Germany.

302403PROM_ENMP

